

# CONTENTS

PRODUCT DESCRIPTION	2
1. Proper use	2
2. Scope of supply / Design	3
2.1 Scope of supply	3
2.2 Design	3
2.3. Operating instructions	4
2.3.1 Controls – front panel	4
2.3.2 Controls – rear panel	4
2.3.3 Controls – hand-held lamp	4
3. Function description	5
4. Technical data	6
5. General features	7
GENERAL SAFETY INSTRUCTIONS	8
1. Explanation of safety symbols used in this manual	8
2. User's due diligence	8
3. Special hazards	9
4. Basic rules on safety precautions	9
5. Basic safety measures	10
6. Requirements concerning the operating personnel	11
INITIAL STARTUP	11
1. General steps to take when starting up	11
2. Adjusting the frequency / speed (internal clock)	12
3. Adjusting the phase shift / slow motion	12
4. Control by an external clock	13
5. Mains synchronous triggering	14
6. Flank	14
7. Power control - dimmer	14
8. Trigger output	15
9. Serial interface	15
MAINTENANCE	15
1. Storage	15
2. Maintenance	15
3. Inspection / Calibration	16
4. Repairs / Disposal	16
ADDITIONAL INFORMATION	17
1. Pin assignments	17
1.1 Socket assignments "external clock"	17
1.2 Hand-held lamp socket	17
2. Problems and remedies	18
3. Replacing the flash tube	20

# Product description

## 1. Proper use

The HELIO-STROB BETA A3 is a stroboscope (light flashing instrument) for industrial applications. This instrument is used to produce snapshots of sequences which, due to the rapidity with which they proceed, are not perceivable by the human eye.



Please note that operating the instrument in explosion-hazardous environment is strictly forbidden.

Appropriate use also includes reading and understanding these operating instructions and complying with the information given in them, especially the safety information. This also includes carrying out all the inspection and maintenance work at the specified intervals.

The operation of stroboscopes may cause failure or interferences of nearby radio devices or radio service. In this case, suspend the operation of the instrument. As a basic principle, keep the operation of the instrument as short as possible.

To avoid personal injury or damage to the equipment, only qualified, trained and authorized personnel should operate the HELIO-STROB BETA A3.

Do not operate the HELIO-STROB BETA A3 with damaged equipment or components. Using damaged components could result in fire or explosion.

Safe operation cannot be assured if the HELIO-STROB BETA A3 is not used in accordance with the above definition of appropriate use.

The user, not the producer, shall assume any liability related to any personal injury or material damage resulted from the inadequate use of the instrument.

## 2. Scope of supply / Design

### 2.1 Scope of supply

The standard scope of supply consists of the following components:

- Control unit
- Hand-held lamp incl. flash tube and connecting cable
- Allen wrench 2.5 mm
- Power connecting cable
- Operation manual

Please check if the scope of supply is complete!

### 2.2 Design

The instruments are designed and manufactured according to acknowledged safety rules and the current state of the art.

The basic design of HELIO-STROB BETA A3 consists of the following components:

Case (control unit)	rugged aluminum case with adjustable unit handle
Case (hand-held lamp)	Metal case with tripod connector and unit handle
Power supply	110V / 230V 50-60 Hz, adjustable by voltage selector
Operation	Function keys and adjusting knob
Display	six-digit seven-segment display
Connection control unit / hand-held lamp	Cable length 2m (standard) Cable connections (pluggable)
Signal input / output	diode female connector



To avoid personal injury and damage to the equipment, repairs must be performed only by professionally trained technicians authorized by ELMED.

Take special care when opening the device and/or the hand lamp, since it is then possible to touch parts carrying a voltage that is considerably higher than the supply voltage.

## 2.3. Operating instructions

### 2.3.1 Controls – front panel

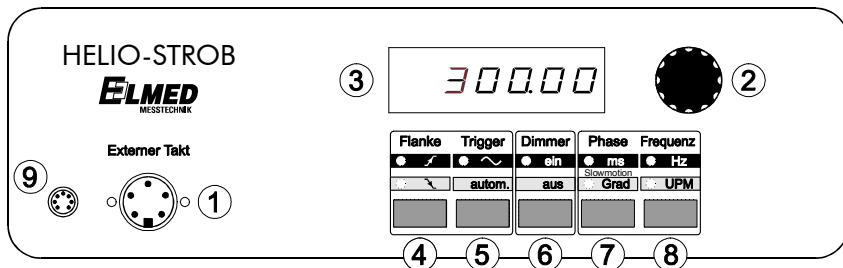

### 2.3.2 Controls – rear panel

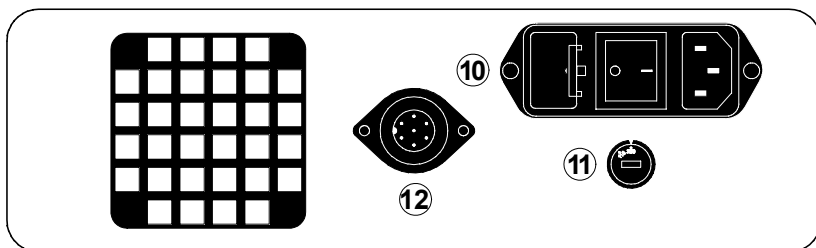

### 2.3.3 Controls – hand-held lamp



### **3. Function description**

Stroboscopes (Greek strobos = rotation, skopein = observe) are used to make snapshots of sequences which due to their rapidity are not perceivable by the human eye.

Tough requirements in industrial use: The HELIO-STROB BETA A3 is right at home in such cases. With a high light output of maximum 9600 Lux, a broad range of control functions and the option to synchronise multiple devices, for the optimum illumination of objects, the HELIO-STROB BETA A3 is a stroboscope for top performance. A robust, service-friendly metal twin-shell case with “stand/handle” and a separate hand lamp provide maximum flexibility and open up new possibilities for applications in the field of the visualisation of movement sequences and vibration processes.

## 4. Technical data

Power supply	110V / 230V 50-60 Hz, adjustable by voltage selector
Power consumption	approx. 150 W
Twin-shell metal case with handle / stand	280 x 240 x 80 (mm)
Weight	approx. 2.8 kg (control unit) approx. 1.5 kg (hand-held lamp)
Light source	Quartz flash tube plug-in, installed in separate hand-held lamp
Internal control of the flash rate by	Twist knob and digital display
External control of the flash rate by	Oscillator, pos. impulse, 5 to 30V
Frequency range internal in Hz / r.p.m.	1 - 315 Hz / 60 - 18900 r.p.m.
Frequency range external in Hz / r.p.m.	1 - 8000 Hz / 60 - 480000 r.p.m.
Measured value display	digital, 6-digit 7-segment display, red, Character height 10mm
Display in Hz / r.p.m.	yes / yes
Measuring range switching	Automatic
Measurement duration	0.33 s (min. 1 period)
Resolution of the display	0.1 - 1 r.p.m. / 0.01 Hz
Phase shifting in degrees/ms	yes / yes
Range degrees/ms	0° - 540° / 0 - 999,99 ms
Resolution degrees/ms	0.1° / 0.001 - 0.01ms
Slow Motion	yes
Range in Hz	-5 Hz - +5 Hz
Resolution in Hz	0,01 Hz
External triggering	Trigger flank can be selected as required by a button, Input frequencies > 315 Hz are divided as whole numbers.

### Light power

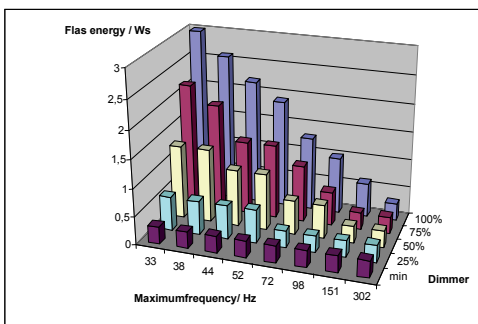

The stroboscope works with minimum flash energy at brightness step 0 (min.)

Light intensity at 50 cm distance	max. 9600 Lux
Overall power	100 W
Operating temperature	0°...+40°C
Storage temperature	-20° ... +60°C
Air humidity	80% relative air humidity at 30°C

## 5. General features

This unit ...

- ... attains its very high, very **constant brightness** by modern switching power supply technology.
- ... is easy to use with **automatic range switching**.
- ... achieves the **high precision** of its frequency and phase shifting due to the applied microprocessor technology.
- ... ensures safe operation by an integrated **monitoring function**.
- ... allows the user to work rationally with its **convenient and simple operation**.
- ... allows use in numerous applications due to the **internal and external triggering**.
- ... is equally suitable for **industrial use** and for **laboratory applications**.
- ... bears the CE symbol.

### Typical fields of application:

- snap-shots of sequences which are not perceivable by the human eye due to their high speed
- vibration analysis
- revolution measurement of rotating objects without applying reflection pads

# General safety instructions

## 1. Explanation of safety symbols used in this manual

The following symbols are used in this manual:

- Safety symbols call attention to adjoining safety notes.
- Instruction symbols indicate important information that should be strictly observed.

This symbol indicates that non-observance could lead to dangers.



This symbol indicates information to be used for a better understanding of processes.



## 2. User's due diligence

The HELIO-STROB BETA A3 has been developed and manufactured in consideration of hazard analyses and in compliance with the relevant harmonized standards as well as the additional technical specifications.

Therefore, the HELIO-STROB BETA A3 is a state-of-the-art instrument and offers a maximum of safety.

This safety can be achieved only if all required safety precautions have been taken. Subject to due diligence, the user of this instrument shall plan such precautions and supervise their execution.



The user shall particularly ensure that



- the HELIO-STROB BETA A3 is used properly (see Chapter Product description)
- the instruments are operated only if in perfect, fully functional condition
- the complete operating instructions are legible and available at the place where the instrument is used
- the instruments are operated only by adequately qualified and authorized personnel which is regularly trained in all aspects related to occupational health and safety; this personnel knows and follows the operation instructions, especially the relevant safety regulations contained therein
- all safety and warning labels are clearly legible and none of them are removed from the instrument.

### 3. Special hazards

	<p><b>In case of users with a neurological proneness to epileptic seizures</b>, the light effects produced by a stroboscope may cause photo induced epilepsy. Users with such predisposition must not use stroboscopes!</p>
---	---

	<p><b>Safety Guidelines for people wearing active implants</b> When using stroboscopes, an influence of active implants (e.g. pacemakers) cannot be completely excluded. For safety reasons we recommend that people wearing active implants are excluded from working with stroboscopes. Persons wearing active implants have expressively to be instructed in this regard.</p>
---	--

### 4. Basic rules on safety precautions

 	<p>Within professional organizations the employer / entrepreneur has to inform the employees / insured workers about the possible hazards related to their work and the safety precautions to be applied. This shall include the current findings regarding hazard avoiding procedures and eyelid protective reflexes.</p>
--	--

- Do not look into the flash tube directly and unprotected as this could be dangerous for the eyes – especially over longer periods of time.
- Due to the dazzle effects caused by the flashlight at short distances, the ability to see may be disturbed in such manner as to make orientation impossible.
- Flashlight shall not be directed to the eyes of other persons.
- In case of a longer or deliberate daily repeated, direct exposure of the eyes to the flash tube, protective goggles (orange glasses) must be worn. In advance, one should be acquainted with the possible change in the color perception of signal and warning indications or the light at the working place.

## 5. Basic safety measures

The basic safety guidelines and regulations of the corresponding professional associations and organisations shall apply.

Before starting up the HELIO-STROB BETA A3, check that the controller, the hand lamp and all the connected cables are undamaged and in perfect working order. Likewise check that all the plug connections have been made correctly (e.g. locking).



Take special care when changing the flash tube.

The flash tube gets very hot in use – danger of burns.

Before touching the flash tube to change it, let it cool down and take the following safety measures:

Switch off the stroboscope

Disconnect the controller from the mains  
(by pulling out the mains power cable)

Remove the plug of the hand lamp cable from the controller.

Allow the flash tube to cool down for at least 5 minutes before removing the reflector housing.

## 6. Requirements concerning the operating personnel

The HELIO-STROB BETA A3 may only be used by persons who have suitably been instructed and authorised. These persons must have read and understood the operating instructions, and in particular the section "Safety and warning information", and then act accordingly.

They must have been instructed in the basic principles of health and safety at work and accident prevention.

### Initial startup



In order to prevent injury or damage when starting up the HELIO-STROB BETA A3, it is essential to comply with the following points:

- The device may only be started up by suitably qualified persons and with due regard for the safety information given here.

	Do not use any parts that have been damaged!
---	--

### 1. General steps to take when starting up

- Connect the hand lamp and the controller.  
Plug in the plug of the hand lamp cable into the corresponding socket ⑫ at the front of the controller and then lock it in place. Turn the switch for the hand lamp so that it is ready for operation.
- Connect the controller to the mains power  
Plug in the plug of the mains cable into the corresponding socket ⑩ at the back of the controller and connect the earthing contact plug of the mains cable to the mains socket.

	The HELIO-STROB BETA A3 is designed for power systems types TN-C and TN-S. These power supply types provide for the immediate switch off of the supply voltage if a contact occurs between supply voltage and grounded components of the instrument. If operated within power systems other than the above, the user shall be liable for the electric safety. Prior to switching on the instrument, check the correct setting of the voltage selector ⑪. The value set by the voltage selector ⑪ must coincide with the level of the supply voltage. The incorrect setting of the voltage selector ⑪ causes damage to the instrument.
	

Switch on the device at the mains switch ⑩ at the back of the controller. After performing a short self-test the unit loads the last values that were set for frequency/r.p.m., phase angle, etc. The current settings can be read from the display and the LEDs. The HELIO-STROB is now ready for operation.

## 2. Adjusting the frequency / speed (internal clock)

“Internal operation” is indicated on the display ③ by the steadily lit decimal point. This mode is selected by pressing the key ⑧. Pressing the key ⑧ again changes the display from Hz to r.p.m.\* (or the reverse). The desired frequency/speed can be adjusted with knob ②. The internal microprocessor controls the function of the knob according to the speed of rotation.

rapid rotation

rapid change in large steps

slow rotation

fine adjustment in small steps

## 3. Adjusting the phase shift / slow motion

The HELIO-STROB is equipped with phase shifting and slow motion, which are available with both an internal and external clock.

These modes can be activated by pressing knob ⑦ one time or repeatedly:

Phase in ms	– upper LED blinks
Phase in degrees	– bottom LED blinks
Slow Motion	– both LEDs blink

After selecting either the mode phase shift in ms or in degrees with key ⑦, the desired phase value can be adjusted with knob ②.

The maximum adjustable phase angle of mode “phase in degrees” is 540°. The LED which indicates the setting “Phase in ms” blinks as soon as a value is set in “ms” which represents a phase angle greater than 540°. The setting will be stored, even if other functions are activated or the stroboscope is switched off and on.

### Note:

The value “phase in ms” is not constant because it is directly dependent upon the adjusted frequency. The reason for this is that the period becomes shorter with an increasing frequency.

By means of the slow motion function the complete motion sequence may be observed. You get the visual impression that the test object is continu-

---

\* revolutions per minute

ously moving slowly. Activate this function by pressing key ⑦. If the function is activated, both status LEDs are lit. For the required slow motion effect positive or negative values can be adjusted by using knob ②. The setting of the corresponding beat frequency ranges between -5 Hz and 5 Hz. The setting will be stored, even if other functions are activated or the stroboscope is switched off and on.

#### 4. Control by an external clock

An external trigger signal can be supplied at the socket ① “External clock”, with the frequency at which the stroboscope is to flash.

The unit can be switched to external mode by pressing key ④. This mode is indicated on the display ③ by a flashing decimal point.

When an external trigger signal is supplied, it must be observed that the signal level and frequency do **not** rise above or fall below the permissible limits of the HELIO-STROB. When the permissible limits are maintained, the stroboscope follows the external clock. Please also observe item “Additional Information - 2 Problems and remedies” and “Product Discription – 4 Technical data”.

When using “external triggering” the function “flank” becomes active. The current setting is indicated by an LED. The function “flank” is described in detail in 6.

If there is no external trigger signal or if the frequency of the external trigger source is less than 1 Hz, this is not shown in the display but instead the display flashes. In the case of external signals > 0 Hz the stroboscope flashes according to the external clock rate. External signals over the range 1 - 8000 Hz are shown in the display. The decimal point flashes to show that the stroboscope is processing a trigger signal that is supplied externally. In the case of frequencies > 8000 Hz the display flashes and shows the value 8000.00 Hz. No flashing is done.

#### **Note:**

Frequencies > 315 Hz are divided as whole numbers. This is shown by one of the two LEDs above the key ⑧ flashing (depending whether the display has been set to show Hz or r.p.m). The actual frequency of the external signal source is shown in the display.

## 5. Mains synchronous triggering

When the key ⑤ is pressed, the unit switches to the trigger mode “mains synchronised”. With this setting, the frequency of the mains supply is used as a trigger signal.

This trigger mode is recommended for the observation of objects moving synchronously with the mains supply. This also applies within limits to movements which represent a multiple or a fraction of the mains frequency. The selection of the trigger mode “mains synchronised” is indicated by an LED. The “flank” function simultaneously becomes active.

The “flank” function is described in detail in 6.

## 6. Flank

The trigger flank selection function automatically becomes active in the trigger modes “mains synchronised” and “external clock”. The current setting can be seen by an LED. Changes in the setting are made by pressing the ④ key.

Function		the flash tube flashes at a change in the trigger signal from “0” to “1”
----------	---	--

Function		the flash tube flashes at a change in the trigger signal from “1” to “0”
----------	---	--

## 7. Power control - dimmer

By means of this function the brightness against the adjusted flash frequency can be regulated. This function is activated by pressing key ⑥, the corresponding LED is lit. Now the brightness can be adjusted in 25 % steps from minimum up to 100 % by using knob ②. As not all steps are available for the whole frequency range, the options are decreasing with increasing flash frequency. The setting will be stored, even if other functions are activated or the stroboscope is switched off and on.

## 8. Trigger output

The HELIO STROB is equipped with a trigger output, to control different devices. The signal between pin 4 and pin 1 of the socket "external clock" corresponds to the TTL level. The period duration depends on the flash rate,  $T_{Low}$  is constant ( $200\mu s$ ).

Signal:

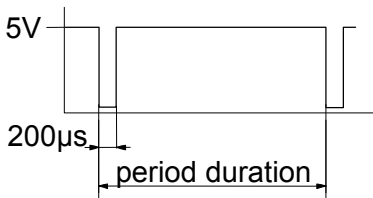

## 9. Serial interface

The firmware of the HELIO-STROB can be updated via the serial interface ⑨. In order to accomplish an update the stroboscope has to be connected to the serial interface of a PC with the attached serial interface cable. The firmware update program is available on our Internet service homepage.

URL: <http://support.elmed.eu/helio/>  
Username: helio  
Password: 8yBMJoDQ

## Maintenance

### 1. Storage

- Protect the instrument from damage by properly storing it in a dry room.
- To avoid condensation see that the storage temperature is kept. Storage temp.:  $-20^{\circ}C \dots +60^{\circ}C$  (warming time constant  $>10K/h$ )

### 2. Maintenance

According to the design, the HELIO-STROB BETA A3 is not susceptible to disturbance. However, the following should be basically observed:

- Do not throw the instrument and do not expose it to heavy shocks.
- Clean the instrument by using only a soft, lightly-moist cloth. Use only mild detergents.

### 3. Inspection / Calibration

To maintain the reliability and the high quality standard of the HELIO-STROB BETA A3 over a long period of time, the instrument should be inspected by the manufacturer each year.

During inspections, all instrument specific functions are checked. A PTB (Physikalisch-Technische Bundesanstalt, the German Bureau of Standards) traceable manufacturer certificate is available on request. The results of inspections shall be documented in inspection sheets and stored in a database.

### 4. Repairs / Disposal

Instruments which are damaged or do not perform according to their specifications shall not be used anymore. To provide for a safe and functional instrument, only original spare parts shall be used for repair.

	To dispose of the old instrument according to legal rules and provisions, please send the HELIO-STROB BETA A3 to the manufacturer.
--	--

If your instrument requires inspection / repair or disposal, please send the unit DDU to:

ELMED Dr.Ing. Mense GmbH  
Stroboskop-Service  
Weilenburgstraße 39  
D- 42579 Heiligenhaus

	Proper execution of maintenance and repair is guaranteed only by the manufacturer or by qualified and authorized service centers.
--	---



## Additional information

### 1. Pin assignments

#### 1.1 Socket assignments “external clock”

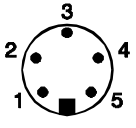
Socket	Pin	Description
	1	0 V (ground)
	2	+5 VDC
	3	10-12 VDC
	4	Trigger output (TTL)
	5	Clock input 5-30 V

#### 1.2 Hand-held lamp socket

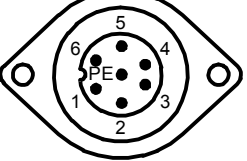
Socket	Pin	Description
	1	Anode voltage
	2	not connected
	3	ignition
	4	115/230 VAC
	5	115/230 VAC
	6	cathode voltage
	PE	protective earth

## 2. Problems and remedies

### **Problem:** No display, no flashing

Possible cause/effect	Possible remedy
No cable connection	Make connection
Unit not switched on	Switch unit on
Mains fuse blown	Replace the fuses

### **Problem:** Unit operates briefly and then switches off

Possible cause/effect	Possible remedy
Poor contact (loose connection)	Check cable/plug
Flash tube defective	Replace flash tube (see 3 Replacing the flash tube)
Flash tube in contact with the reflector	Insert flash tube centrally, replace silicone ring if necessary

### **Problem:** No flashing, display and frequency adjustment in operation

Possible cause/effect	Possible remedy
Flash tube defective	Replace flash tube (see 3 Replacing the flash tube)
Hand-held lamp not switched on	Press the switch on the hand-held lamp
No connection between the hand-held lamp and the control unit	Check the plug and cable

### **Problem:** Flash sequence not periodic (intermittent ignition)

Possible cause/effect	Possible remedy
Flash tube shows signs of ageing due to long period of use	Replace flash tube (see 3 Replacing the flash tube)

### **Problem:** Storage of the values for speed and phase angle in the memory does not work

Possible cause/effect	Possible remedy
The unit is switched off too quickly after the values have been adjusted	Allow two seconds to expire between adjusting the values and switching off

**Problem:** Display blinks and indicates minimum frequency, flash tube flashes

Possible cause/effect  
External clock is lower than the lower limit of the range, the frequency cannot be displayed, the stroboscope flashes with the external clock

**Problem:** Display blinks and indicates maximum frequency, flash tube flashes

Possible cause/effect  
External clock is faster than the maximum permissible frequency | Reduce the frequency of the external trigger signal



**Problem:** Despite the supply of an external trigger signal, the unit does not switch to the external clock, the unit flashes with the internally generated clock

Possible cause/effect	
External signal is not detected	Check cable/plug Compare the pin assignment of the plug with the "external clock" socket (see 1.1)
Signal level too low	Raise the input level (see 4.); if impossible, check whether a trigger adapter can be used
Stroboscope was not switched to external mode yet	Press key ④

**Problem:** Results of measurement do not conform with the expected result

Possible cause/effect	Possible remedy
Measured object behaves not as expected	Check the object
Operator error	Repeat the measurement

### 3. Replacing the flash tube

	To avoid personal injury or damage to the equipment, install only approved flash tubes in this stroboscope. Unapproved flash tubes could cause a fire or explo-	
--	---	---

The flash tube is a consumable part that must be replaced sooner or later depending on the intensity of the usage. Unlike the glow lamp, in which a defect can be detected easily (burnout), the indication of a flash tube defect can be different:

- Reduced brightness,
- Unsteady light (flickering),
- Discoloured bulb jacket.

To replace the flash tube, please proceed as follows:

- Switch the stroboscope off and pull out the power plug from the mains socket.
- Disconnect the hand-held lamp by removing the hand-held lamp plug from the control component.
- If you have operated the flash tube before, you must wait for at least 5 minutes before executing the next steps for the flash tube to cool down.  
**Danger of burns!**
- Remove the surrounding edge protection and loosen the four mounting screws of the protective disk. Use the internal hexagon wrench included in the delivery scope for this purpose. The protective disk can now be taken out along with the reflector. Caution: For safety against electric shocks, the reflector is connected to the housing with the help of an earthing cable. Do not disturb this connection!
- Take the old flash tube out of the insertion base by pulling the two facing stud bolts projecting from the base or on the installation ring.
- Take the new flash tube out of the packing. Avoid touching the lamp jackets with the fingers. Insert the flash tube into the base. While inserting the flash tube, touch only the stud bolts or the installation ring. The connecting points are arranged such that wrong polarity of the flash tube can be ruled out completely. Insert the new flash tube into the base fully; otherwise there may be reduced brightness or lack of uniformity in the light intensity.
- Install the protective disk containing the reflector properly with the help of the four mounting screws. **Important!** Please check whether the flash tube sits in the centre of the reflector cutout. The flash tube should not touch the reflector under any circumstances, as otherwise there can be **malfunctions!**
- Please also check the silicon ring in the reflector for damages; It provides protection against flashovers between flash tube and reflector.
- Finally, replace the edge protection on the hand-held lamp housing.